

Linear

LINI Glow XL A040 (40W) Fixture Guide

KKDÖ

Indoor | Surface | Output up to 2680lm/m (817lm/ft)



Key applications

- ✓ Architectural detail
- ✓ Cabinet & furniture
- ✓ Direct lighting
- ✓ Interior
- ✓ Mirror back lighting

Key features

- ✓ A-line (High Efficacy)
- ✓ Custom lengths
- ✓ Constant Voltage (CV)
- ✓ Continuous light runs
- ✓ Diffusion: homogenous
- ✓ Direct view
- ✓ High lumen efficacy
- ✓ IP40 dry area

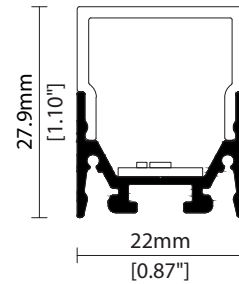

MOUNTING METHODS

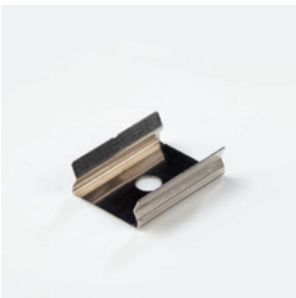

KKCP-11 Concealed clip

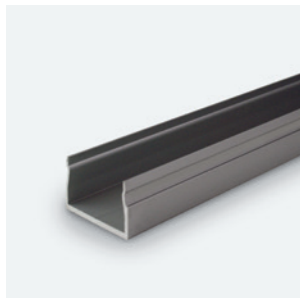

KKCR-01-1000 Cable raceway (1000mm)
KKCR-01-2000 Cable raceway (2000mm)
KKCR-01-3000 Cable raceway (3000mm)



KKJT-02 Joining bar

Linear

LINI Glow XL A040 (40W)

Specification sheet



Dimensions	H28/W22/L88-1511mm (H1.1/W0.87/L3.46-59.49in)
PCB Cut-point	38.46mm increment/1500mm max (1.51in increment/59.06in max)
LED Pitch	4.8mm - 208LED/m (0.19in - 64LED/ft)
Chip	A-line
Cover/Optics	Diffused (156°)
CCT	A-line: 2700K/3000K/3500K/4000K
LED binning	A-line: 3-step MacAdam ellipse
CRI	≥94
Lifetime	50,000 hours @ 25°C (50,000 hours @ 77°F)
Operating temp	T _a = -25 to 45°C (T _c max = 86°C) T _a = -13 to 113°F (T _c max = 187°F)
IP Rating	IP40
Finish	Silver anodised
Mounting	Surface mounting via concealed clips or cable raceway
Power feed	Hardwire tails or male/female connectors
Control	0-10V/1-10V/DMX/DALI



LED Grading Key

Exclusive Grade *KKDC tuned CCT range
A-line* 3-step CCT range
 KKDC highest lumen efficacy LED

Power consumption	Supply voltage	Supply current
40W/m (12.19W/ft)	24V DC	1.67A/m (0.51A/ft)

Performance Data (3000K)

	R1	R2	R3	R4	R5	R6	R7	R8	R9	R10	R11	R12	R13	R14		
A-line	95	95	94	95	94	94	95	89	73	88	95	79	95	96		
	Diffused Cover												CRI	R9	Rf	Rg
A-line	2680lm/m (817lm/ft) 67lm/W												94	73	-	-

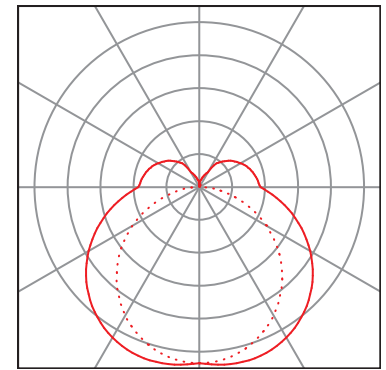
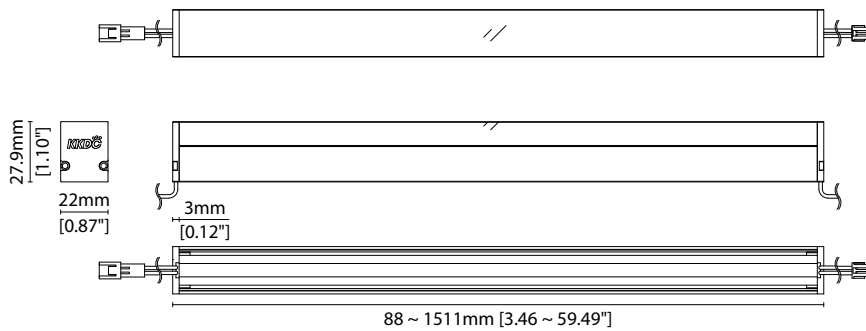

— C0 / C180 cd / 1000 lm - - - C90 / C270

Data derived from independent UKAS/IESNA LM-79-08 accredited testing of production samples.

LINI Glow XL A040 (40W)

Code Table



FIXTURE

Model	Finish	Cover	Grade ¹	LED	Colour (CCT)	Length Availability ²	IP	Cable Length	Power Feed ³	Input
LINI Glow XL	GX Silver Anodised	SA Diffused U cover	0 A- A	A040 040	2700K 27 3000K 30 3500K 35 4000K 40	m 88-1511mm 38.46mm increments i 3.46-59.49in 1.51in increments (Specify length code OR total run length)	IP40 40	300mm/ 0300 11.81" 1000mm/ 1000 39.37"	Single no sheath tail S00X Double no sheath tail D00X Single no sheath IP20 connector S20X Double no sheath IP20 connector D20X	DC 24V g

¹ Refer to **LED Grading Key** on **Specification sheet** page

² Refer to **Length Availability List** or enter total run length instead of length code

³ Refer to **Power Feed Options** on **Options** pages

Code Example:

GX	-	SA	-	0	-	A	-	040	-	30	-	m	511	-	40	-	0300	-	D00X	-	g
LINI Glow XL		Silver Anodised		Diffused U cover		A-		A040		3000K		511mm		IP40		300mm/11.81"		Double no sheath tail		DC 24V	

ACCESSORIES

Mounting Accessories

KKCP-11	Concealed Clip
KKCR-01-1000	1000mm/39.37" Cable Raceway
KKCR-01-2000	2000mm/78.74" Cable Raceway
KKCR-01-3000	3000mm/118.11" Cable Raceway
KKJT-02	Joining Bar (allow one per join)

* Refer to **Mounting accessories** on **Accessories** pages

Connection Accessories

KKCN-01	2 PIN male & female 50mm/1.97" pair
KKCN-03	2 PIN male & female 300mm/11.81" pair
KKCN-06	2 PIN 300mm/11.81" extension lead

* Refer to **Power feed** on **Accessories** pages

PSU/Driver

0-10V/1-10V/DALI/DMX

* Refer to **Driver/PSU Options** page for details or provide requirement and KKDC to offer the suitable option

LED ENGINE VARIANTS (LED STRIP TYPE)

Colour	LED	Lumen/m	Lumen/ft	W/m	W/ft	Spec Doc	Length	Increment
Single CCT	R007	386	118	7	2.13	LINI Glow XL R007	94-2011mm (3.71-79.17in)	41.7mm (1.64in)
	R014	801	244	14	4.27	LINI Glow XL R014	94-2011mm (3.71-79.17in)	41.7mm (1.64in)
	R020	1145	349	20	6.1	LINI Glow XL R020	94-2011mm (3.71-79.17in)	41.7mm (1.64in)
	A040	2680	817	40	12.19	LINI Glow XL A040	88-1511mm (3.46-59.49in)	38.46mm (1.51in)
Warm Dim/Dynamic White	R207	899	274	16	4.88	LINI Glow XL R207	94-2011mm (3.71-79.17in)	83.3mm (3.28in)
RGB	501	Red 90 Green 193 Blue 32 RGB 280	Red 27 Green 59 Blue 10 RGB 85	15.6	4.75	LINI Glow XL RGB	94-2011mm (3.71-79.17in)	83.3mm (3.28in)
RGBW	R201	689	210	20	6.1	LINI Glow XL RGBW	136-2011mm (5.35-79.17in)	62.5mm (2.46in)

* Performance data: A/s-line, diffused cover, 3000K

Linear

LINI Glow XL A040 (40W)

Length Availability List



Length Code		Fixture Length ¹		LED Strip ²		End Cap Dimension ³		Wattage (W)	Output (lm)
Metric	Imperial(US)	Metric	Imperial(US)	Metric	Imperial(US)	Metric	Imperial(US)		3000K (Test Data)
m0088	i0003	88mm	3.46in	77mm	3.03in	6mm	0.24in	3.08	206
m0126	i0005	126mm	4.98in	115mm	4.55in	6mm	0.24in	4.62	309
m0165	i0006	165mm	6.49in	154mm	6.06in	6mm	0.24in	6.16	413
m0203	i0008	203mm	8.01in	192mm	7.57in	6mm	0.24in	7.70	516
m0242	i0010	242mm	9.52in	231mm	9.09in	6mm	0.24in	9.23	619
m0280	i0011	280mm	11.04in	269mm	10.60in	6mm	0.24in	10.77	722
m0319	i0013	319mm	12.55in	308mm	12.12in	6mm	0.24in	12.31	825
m0357	i0014	357mm	14.06in	346mm	13.63in	6mm	0.24in	13.85	928
m0396	i0016	396mm	15.58in	385mm	15.14in	6mm	0.24in	15.39	1031
m0434	i0017	434mm	17.09in	423mm	16.66in	6mm	0.24in	16.93	1134
m0473	i0019	473mm	18.61in	462mm	18.17in	6mm	0.24in	18.46	1237
m0511	i0020	511mm	20.12in	500mm	19.69in	6mm	0.24in	20.00	1340
m0550	i0022	550mm	21.63in	539mm	21.20in	6mm	0.24in	21.54	1443
m0588	i0023	588mm	23.15in	577mm	22.72in	6mm	0.24in	23.08	1546
m0626	i0025	626mm	24.66in	615mm	24.23in	6mm	0.24in	24.62	1649
m0665	i0026	665mm	26.18in	654mm	25.74in	6mm	0.24in	26.16	1752
m0703	i0028	703mm	27.69in	692mm	27.26in	6mm	0.24in	27.69	1856
m0742	i0029	742mm	29.21in	731mm	28.77in	6mm	0.24in	29.23	1959
m0780	i0031	780mm	30.72in	769mm	30.29in	6mm	0.24in	30.77	2062
m0819	i0032	819mm	32.23in	808mm	31.80in	6mm	0.24in	32.31	2165
m0857	i0034	857mm	33.75in	846mm	33.31in	6mm	0.24in	33.85	2268
m0896	i0035	896mm	35.26in	885mm	34.83in	6mm	0.24in	35.39	2371
m0934	i0037	934mm	36.78in	923mm	36.34in	6mm	0.24in	36.92	2474
m0973	i0038	973mm	38.29in	962mm	37.86in	6mm	0.24in	38.46	2577
m1011	i0040	1011mm	39.80in	1000mm	39.37in	6mm	0.24in	40.00	2680
m1050	i0041	1050mm	41.32in	1039mm	40.89in	6mm	0.24in	41.54	2783
m1088	i0043	1088mm	42.83in	1077mm	42.40in	6mm	0.24in	43.08	2886
m1126	i0044	1126mm	44.35in	1115mm	43.91in	6mm	0.24in	44.62	2989
m1165	i0046	1165mm	45.86in	1154mm	45.43in	6mm	0.24in	46.16	3092
m1203	i0047	1203mm	47.38in	1192mm	46.94in	6mm	0.24in	47.69	3195
m1242	i0049	1242mm	48.89in	1231mm	48.46in	6mm	0.24in	49.23	3299
m1280	i0050	1280mm	50.40in	1269mm	49.97in	6mm	0.24in	50.77	3402
m1319	i0052	1319mm	51.92in	1308mm	51.49in	6mm	0.24in	52.31	3505
m1357	i0053	1357mm	53.43in	1346mm	53.00in	6mm	0.24in	53.85	3608
m1396	i0055	1396mm	54.95in	1385mm	54.51in	6mm	0.24in	55.39	3711
m1434	i0056	1434mm	56.46in	1423mm	56.03in	6mm	0.24in	56.92	3814
m1473	i0058	1473mm	57.97in	1462mm	57.54in	6mm	0.24in	58.46	3917
m1511	i0059	1511mm	59.49in	1500mm	59.06in	6mm	0.24in	60.00	4020

¹ Actual total overall length of light fixture (LED strip + end caps + void/wire hole)

² Actual length of PCB strip

³ Actual length of 2x end caps

Linear

LINI Glow XL A040 (40W)

Length Availability List

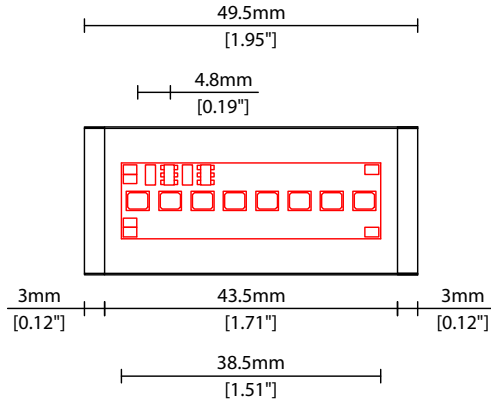

Linear

LINI Glow XL A040 (40W) Options

KKDC

COVER/LENS OPTIONS

* Options are an integral part of the fixture ordering codes. Please refer to **Code Table** pages.

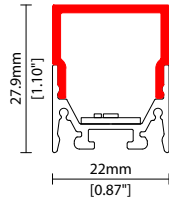

0 Diffused U cover

W22/H27.9mm (W0.87/H1.10")

POWER FEED OPTIONS

0300 S00X 300mm (11.81") Single no sheath tail

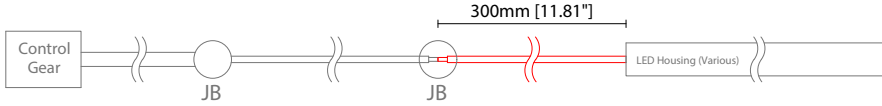

0300 D00X 300mm (11.81") Double no sheath tail

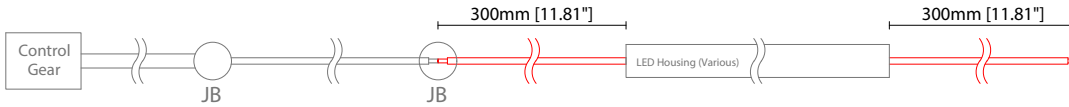

0300 S20X 300mm (11.81") Single no sheath IP20 connector

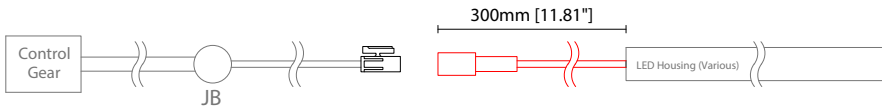

0300 D20X 300mm (11.81") Double no sheath IP20 connector

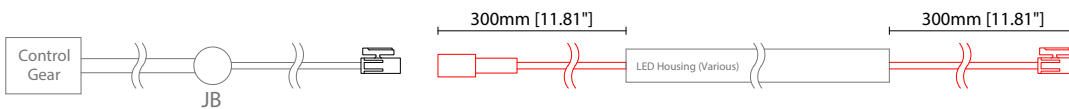

1000 S00X 1000mm (39.37") Single no sheath tail

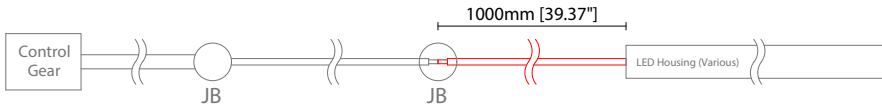

1000 D00X 1000mm (39.37") Double no sheath tail

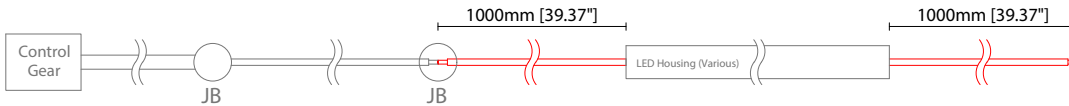

1000 S20X 1000mm (39.37") Single no sheath IP20 connector

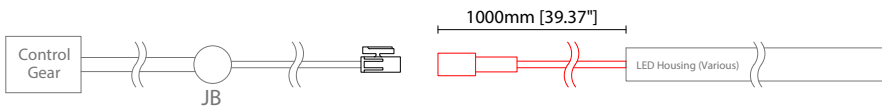

1000 D20X 1000mm (39.37") Double no sheath IP20 connector

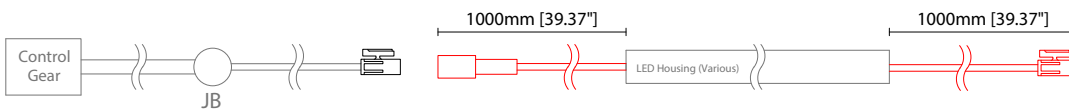

Key

Control Gear Power supply, sub-controllers & control systems
 JB Junction box / cable connection

Linear

LINI Glow XL A040 (40W) Options



POWER FEED OPTIONS (CONTINUED)

2 Pin Female Connector

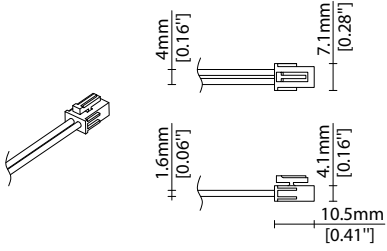

2 Pin Male Connector

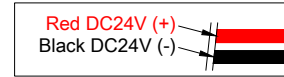
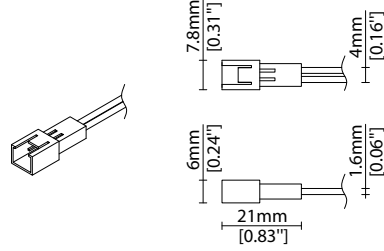

MOUNTING ACCESSORIES

Note: Accessories are to be ordered separately with corresponding code shown below.



KKCP-11
 Concealed clip
 (allow 3 per metre/40in)
 S/Steel finish
 L20/W22/H28.1mm
 (L0.79/W0.87/H1.11")

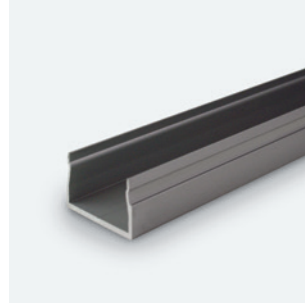
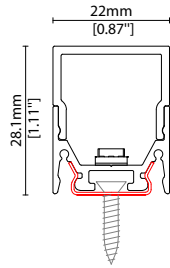

KKCR-01-1000 1000mm (39.37in)
KKCR-01-2000 2000mm (78.74in)
KKCR-01-3000 3000mm (118.11in)
 Cable raceway*
 Anodised aluminium finish
 W22/H36.4mm (W0.87/H1.43")
 * Cut & drilled to fit on site

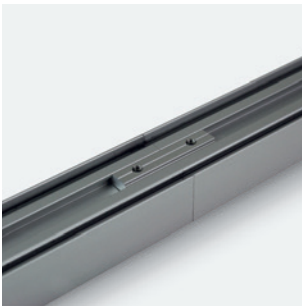
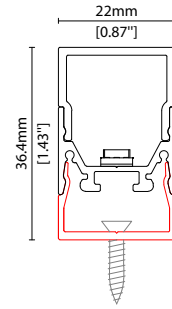

KKJT-02
 Joining bar* (allow 1 per join)
 Anodised aluminium finish
 L25mm (L0.98")
 * Mounting option required with
 Joining bar

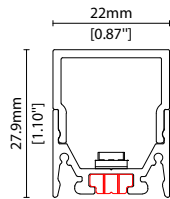

POWER FEED

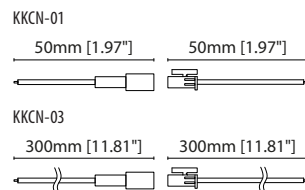
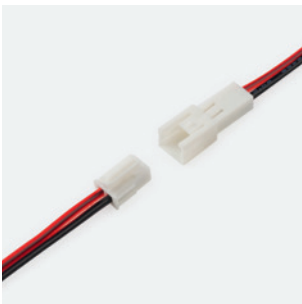

KKCN-01 50mm (1.97in) pair
KKCN-03 300mm (11.81in) pair
 2 PIN male + female connector set

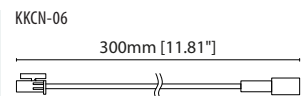

KKCN-06
 2 PIN 300mm (11.81in) extension
 lead

Linear

LINI Glow XL A040 (40W) Accessories

KKDC

KKDC CONTROL



IP20
Plastic housing
L170/W59/H29mm
(L6.69/W2.32/H1.14in)

KKDM-06 1-10V

visDIM dimmable sub-controller
(4 x 8A max @ 12-36V)



IP20
Plastic housing
L170/W53.4/H28mm
(L6.69/W2.10/H1.10in)

KKSC-05 DMX

visDIM dimmable sub-controller
(4 x 5A max @ 12-36V)



IP20
Plastic housing
L170/W59/H29mm
(L6.69/W2.32/H1.14in)

KKDL-02 DALI

visDIM dimmable sub-controller
(4 x 8A max @ 12-36V)



IP20
Plastic housing
L166/W53.4/H23mm
(L6.54/W2.10/H0.91in)

KKDL-03 DALI

visDIM dimmable sub-controller
(4 x 5A max @ 12-36V)

AVAILABLE PSU OPTIONS

Control Mode	PSU (Order Code)	Input Voltage AC	Output Voltage DC	Rated Output Current	Rated Power	Dim %	IP Rating
Switched	CEN-60-24	90-295V	24V	2.5A	60W	-	IP67
	HLG-60H-24	90-305V	24V	2.5A	60W	-	IP67
	HLG-100H-24	90-305V	24V	4.0A	100W	-	IP67
	HLG-150H-24	90-305V	24V	6.3A	150W	-	IP67
	HLG-240H-24	90-305V	24V	10A	240W	-	IP67
0-10V (1-10V)	PWM-40-24	90-305V	24V	1.67A	40W	100-0.15 (100-10)	IP67
	PWM-60-24	90-305V	24V	2.5A	60W	100-0.15 (100-10)	IP67
	PWM-90-24	90-305V	24V	3.67A	90W	100-0.15 (100-10)	IP67
	PWM-120-24	90-305V	24V	5.0A	120W	100-0.15 (100-10)	IP67
DALI	LIN100A1	120-277V	24V	1A per channel	100W	100-0.1	IP66/IP40
DMX RGB	LIN100A1	120-277V	24V	1.33A per channel	100W	100-0.1	IP66/IP40
DMX RGBW	LIN100A1	120-277A	24V	1A per channel	100W	100-0.1	IP66/IP40

Flicker Free Options - Combination of PSU+ sub-controller

Control Mode	PSU (Order Code)	Sub-controller (Order Code)	Input Voltage AC	Output Voltage DC	Rated Output Current	Rated Power	Dim %	IP Rating PSU/ Sub-controller
0-10V or 1-10V	CEN-60-24	KKDM-06	90-295V	24V	2.5A	60W	100-0.9	IP67/IP20
	HLG-60H-24	KKDM-06	90-295V	24V	2.5A	60W	100-0.9	IP67/IP20
	HLG-100H-24	KKDM-06	90-295V	24V	4.0A	100W	100-0.9	IP67/IP20
	HLG-150H-24	KKDM-06	90-295V	24V	6.3A	150W	100-0.9	IP67/IP20
	HLG-240H-24	KKDM-06	90-295V	24V	10.0A	240W	100-0.9	IP67/IP20
DALI	CEN-60-24	KKDL-02/03	90-295V	24V	2.5A	60W	100-0.1	IP67/IP20
	HLG-60H-24	KKDL-02/03	90-305V	24V	2.5A	60W	100-0.1	IP67/IP20
	HLG-100H-24	KKDL-02/03	90-305V	24V	4.0A	100W	100-0.1	IP67/IP20
	HLG-150H-24	KKDL-02/03	90-305V	24V	6.3A	150W	100-0.1	IP67/IP20
	HLG-240H-24	KKDL-02/03	90-305V	24V	10.0A	240W	100-0.1	IP67/IP20
DMX RGB	CEN-60-24	KKSC-05	90-295V	24V	2.5A	60W	100-0.9	IP67/IP20
	HLG-60H-24	KKSC-05	90-305V	24V	2.5A	60W	100-0.9	IP67/IP20
	HLG-100H-24	KKSC-05	90-305V	24V	4A	100W	100-0.9	IP67/IP20
	HLG-150H-24	KKSC-05	90-305V	24V	6.3A	150W	100-0.9	IP67/IP20
	HLG-240H-24	KKSC-05	90-305V	24V	10.0A	240W	100-0.9	IP67/IP20

¹ The items shown above cover the most frequently used specification but does not exhaust the possible options

² PSU and/or driver can be chosen from the table, or KKDC may recommend the best option upon receipt of the controls requirement and installation environment

³ Electrical shop drawing will include detailed information of PSU and relevant control drivers

⁴ Cut sheets are available on the controls section of www.kkdc.lighting or upon request